



Federation of Governing Bodies of South African Schools  

---

Federasie van Beheerliggame van Suid-Afrikaanse Skole

# Launching your Technology plan...



FEDSAS

DIGITAL  
Citizenship

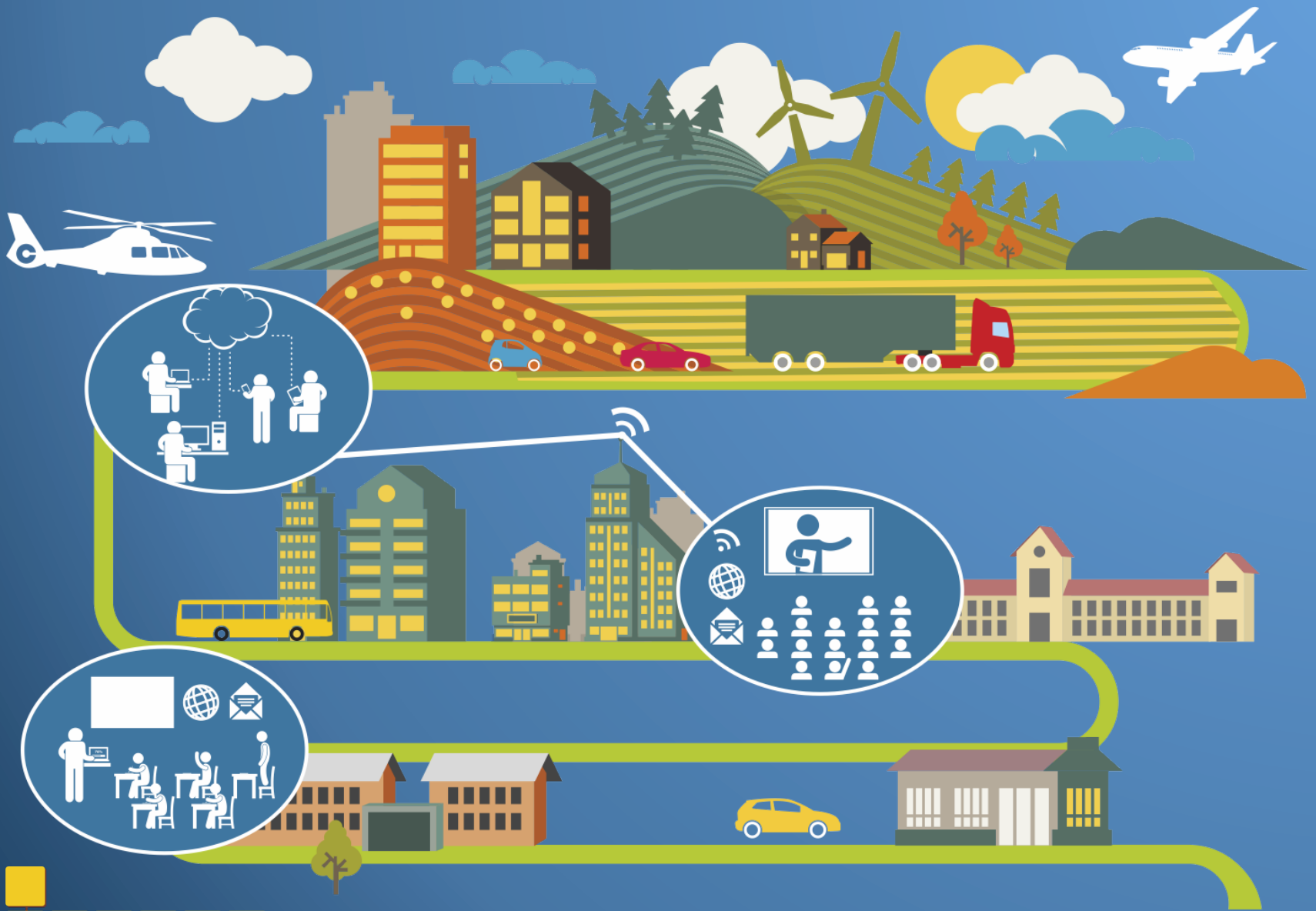

FEDSAS

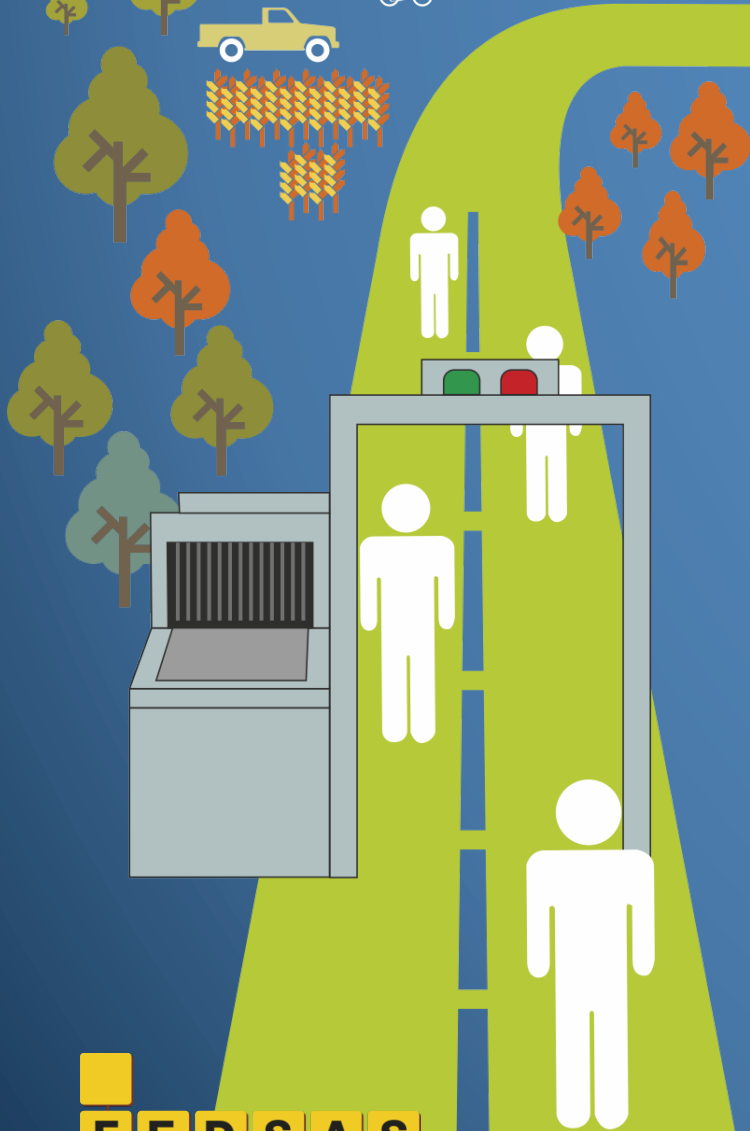

FEDSAS

DIGITAL  
Citizenship

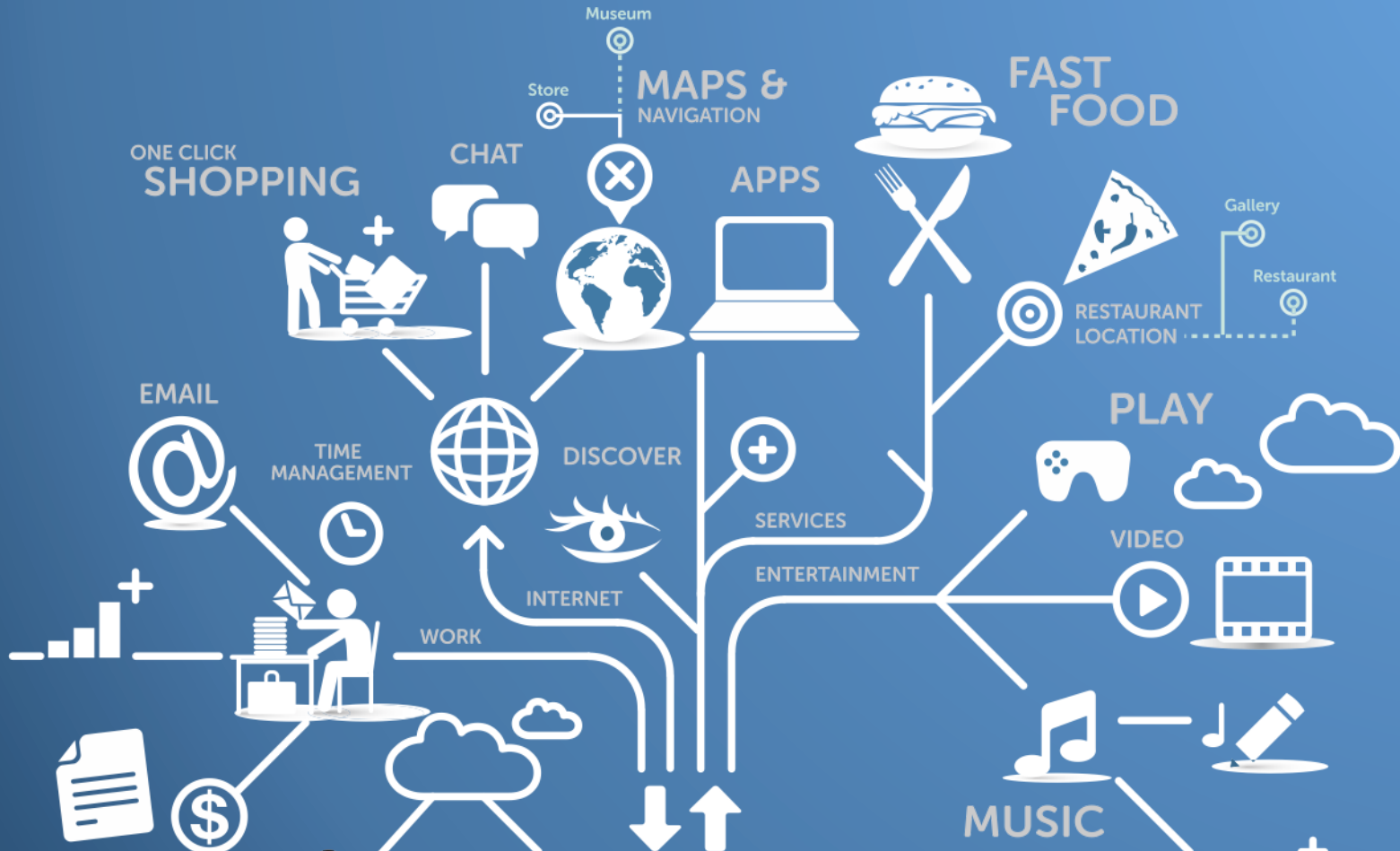

**DIGITAL**  
Citizenship



1

## Tegnologiese Vlak

Die skool beskik oor swartborde, 'n faks masjien en soms ook e-pos. Geen tegnologiese infrastruktuur.



2

## Tegnologiese Vlak

Die skool beskik oor data projektors, interaktiewe witbord, e-pos, intranet asook 'n webblad. Medium tegnologiese infrastruktuur.



3

## Tegnologiese Vlak

Die skool beskik interaktiewe witboard, tablette, Wi-Fi, papierlose kommunikasie. Tegnologies gevorderde ingrastruktuur.

Conrad Steyn  
[conrads@d7.co.za](mailto:conrads@d7.co.za)  
073 386 5336

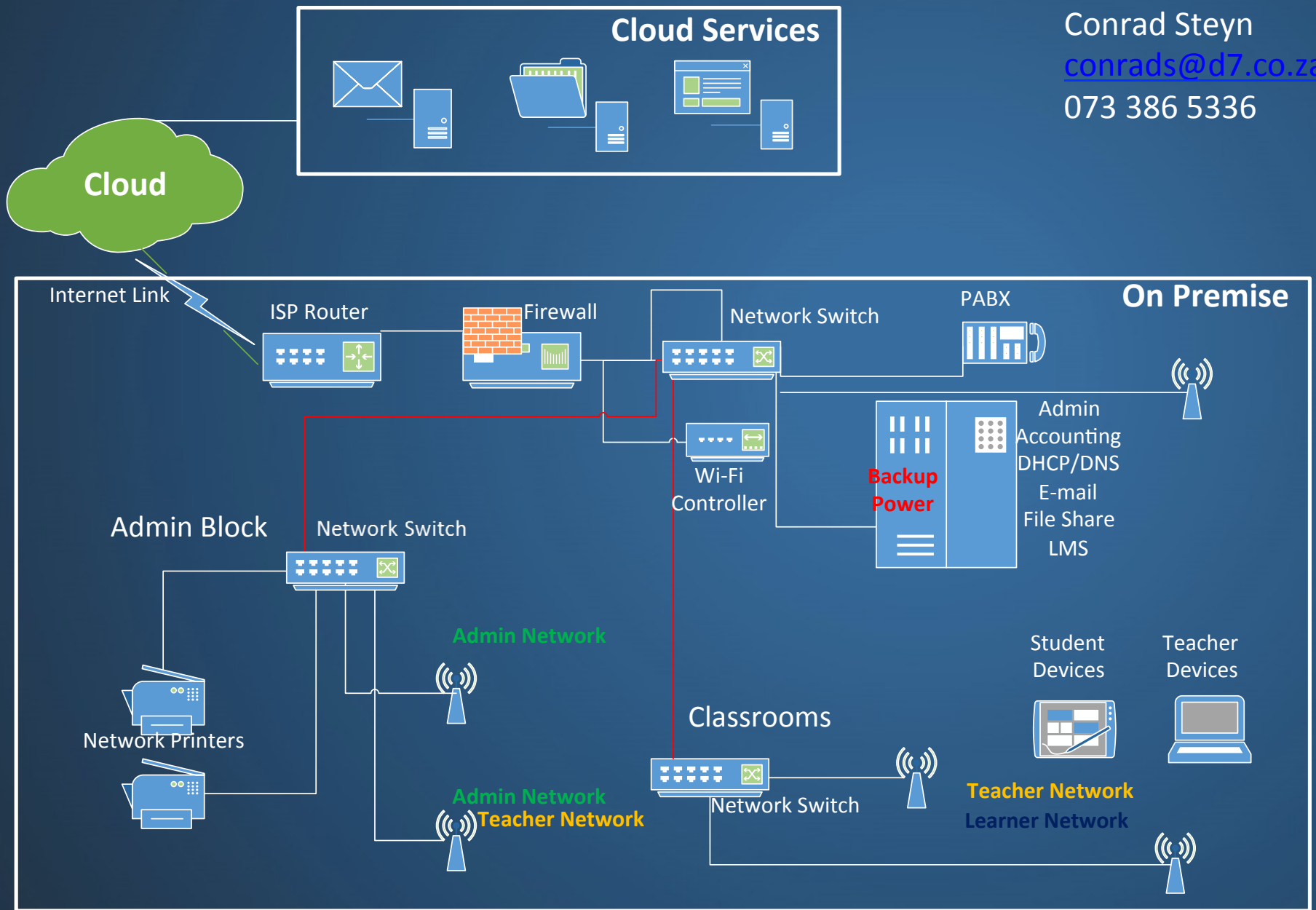

# Wired Network

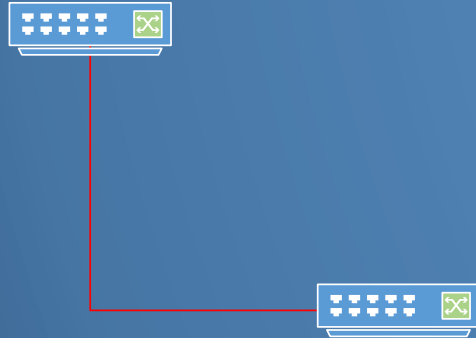

- Network Design
- Configuration
- Hardware Selection
- Cabling Selection
- Live Monitoring and Reports

# Wireless Network

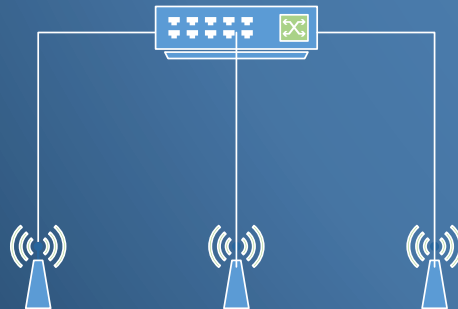

- Wireless Standards and Performance
- MIMO example 3x3:3
- Security and Access Management
- BYOD (Bring Your Own Device)
- VLAN (Virtual Local Area Network)
- Access Point Layout and cabling
- Live Monitoring and Reports





# Internet Connectivity Options



Optic Fiber



Wi-Fi Link



Satellite



ADSL

# Security

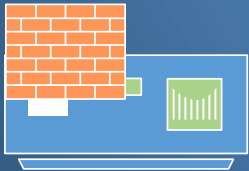

- Firewall
- Content Filter
- Anti-Virus & Spam Control
- Live Network Monitoring and Reports
- Multi WAN (With Failover)

## Cloud Services

- E-mail
- Intranet
- LMS
- Administration Software

## Virtualization

- Network Virtualization
- Server Virtualization
- Storage Virtualization

## Backup\Alternative Power

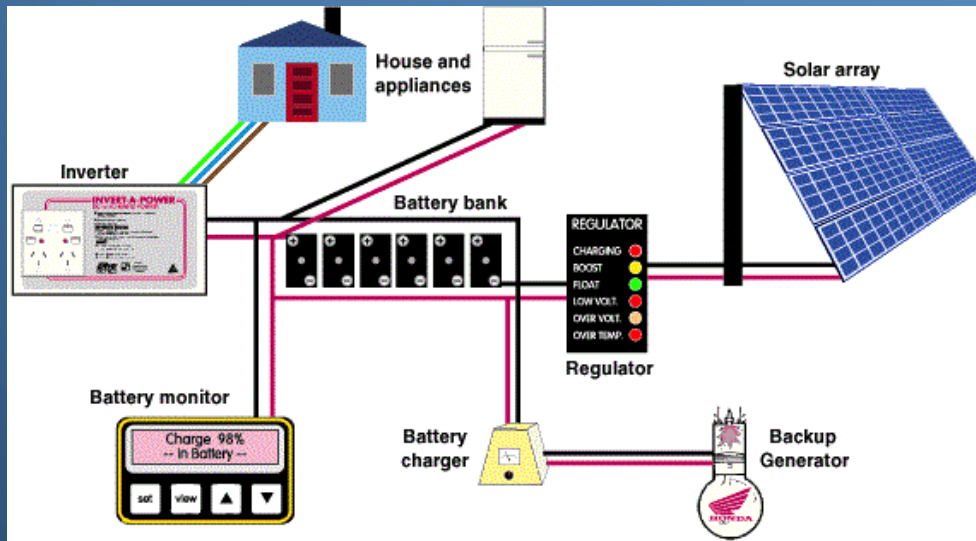

- Backup Power
- On the Grid
- Off the Grid
- Hybrid

KEEP CALM



IS HERE TO HELP



DIGITAL  
Citizenship